

# BS/BSS 1250 = BS/BSS 75

Inner heights=H  
75 mm

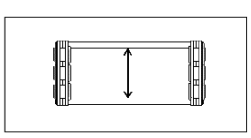

Inner widths=A  
75-500 mm

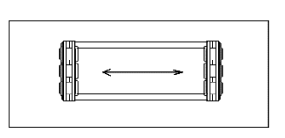

Pitch=P  
125mm

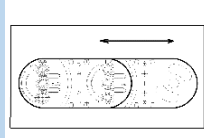

Radius=R  
150-900

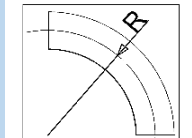

SP

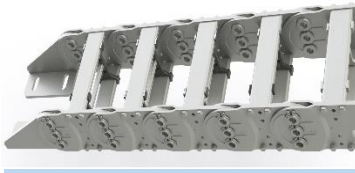
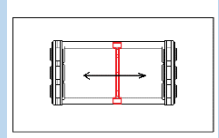

**BS/BSS 1250A** (STANDARD)  
HER BAKLADA ÇİFT ALÜMİNYUM ÇİTA TAKILI  
İÇ VE DIŞ ÇTALAR SÖKÜLEBİLİR  
AYARLANABİLİR PLASTİK SEPERATÖR  
KABLO TEMASLARI ÖNLENİR

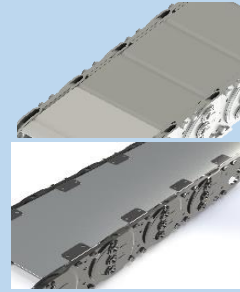

**BS/BSS 1250 K**  
K SERİSİ  
ALÜMİNYUM KAPAK SİSTEMİ

K1 SERİSİ  
ÇELİK BANT KAPAK SİSTEMİ



**BS/BSS 1250 PF** (PIPE FRAME)  
ÇELİK BÖLÜCÜLERLE VE DÖNEBİLEN  
BORULARLA YUMUŞAK KABLO DESTEĞİ  
YUMUŞAK KILIFLI MEDYA HORTUM VE  
KABLOLARINI KULLANMAK İÇİN İDEALDİR



**BS/BSS 1250 B** (LG SERİSİ)  
ZİNCİR BOYUNCA OPTİMUM KABLO YÖNLENDİRME  
KABLOYU HASAS SARAR VE KESMEZ  
ÇİVATA BİRLEŞTİRMELİ SÖKÜLEBİLİR

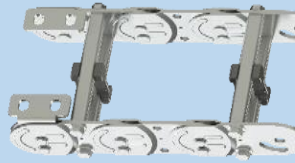

**BS/BSS 1250 SF** (SINGLE FRAME)  
İKİ BAKLADA BİR ALÜMİNYUM ÇİTA TAKILI  
İÇ VE DIŞ ÇTALAR SÖKÜLEBİLİR  
AYARLANABİLİR PLASTİK SEPERATÖR

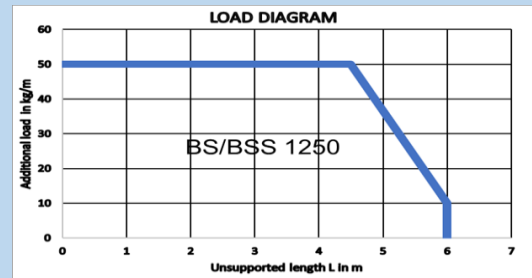
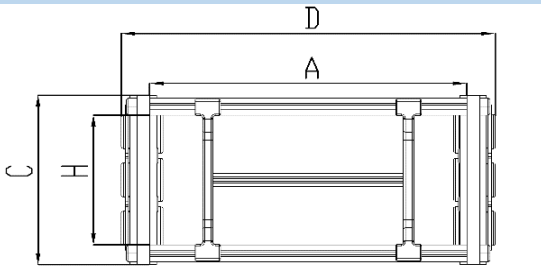

ÜRÜN KODU	H=İÇ YÜKSEKLİK	A=İÇ GENİŞLİK	C=DIŞ YÜKSEKLİK	D= DIŞ GENİŞLİK	R=KIVRILMA YARIÇAPI
PRODUCT CODE	INNER HEIGHT	INNER WIDTH	OUTER HEIGHT	OUTER WIDTH	BENDING RADIUS
BS 1250	75 mm	75-500 mm	98 mm	A+27 mm	150-900

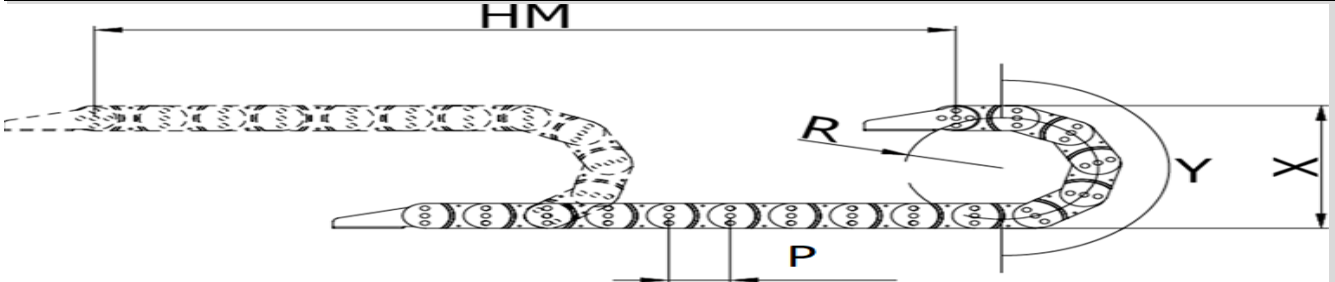

L= KULANILACAK MİKTAR	HM= HAREKET MESAFESİ	X= MONTAJ YÜKSEKLİĞİ	P= HATVE	Y= RADIUS MESAFESİ
CHAIN LENGTH	MOVEMENT DISTANCE	MOUNTING HEIGHT	PITCH	RADIUS DISTANCE
$L=HM/2+Y$		$Y=R/\pi$		$X=RX2+C$

ÖRNEK SİPARİŞ ORDER EXAMPLE  
BS1250(BS75) A100 R100 L5000

ÜRÜN KODU	A= ACIK K= KAPALI B =ÖZEL İŞLEME(LG)	R=KIVRILMA YARI ÇAPI	L=ZİNCİR BOYU
PRODUCT CODE	A= OPEN K= CLOSED B =(LG)	R=BENDING RADIUS	(CHAIN LENGTH)
BS1250	A 100	R100	L=5000 mm

ÖRNEK GÖRÜNÜM SAMPLE VIEW



BAĞLANTI TİPİ CONNECTION TYPE

BS/BSS1250 = BS/BSS75

AYAK BAĞLANTI TİPLERİ RESİMDEKİ GİBİDİR  
END BRACKET TYPES AS IN THE PICTURE  
AYRICA DİK BAĞLANABİLİR  
ALSO VERTICAL CONNECTING IS POSSIBLE

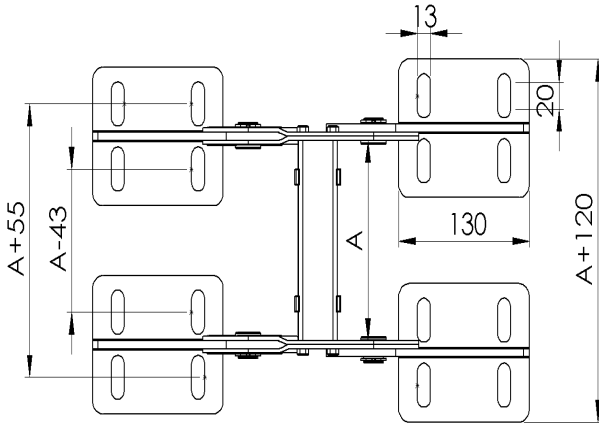

SEPERATİST

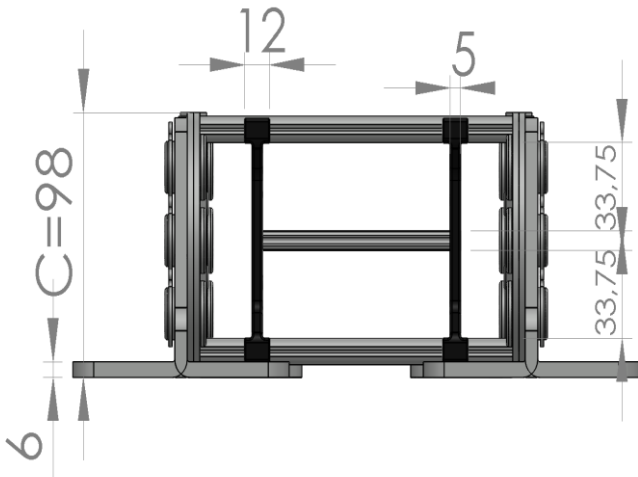

KABLO KANALI PLASTİK SEPERATÖRLERLE BÖLÜNÜR  
CABLE CHANNEL DIVIDED WITH PLASTIC SEPERATORS  
ÇALIŞIRKEN İÇERDE SÜRTÜNMEYİ ÖNLER  
prevents internal friction  
YUMUŞAK DOKULU MEDYA KABLOLARI İÇİN İDEALDİR  
IDEAL FOR SOFT TISSUE MEDIA CABLES