

BS/BSS 1000 = BS/BSS 60

Inner heights=H
60 mm

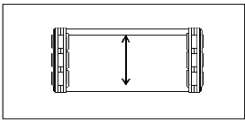

Inner widths=A
40-500 mm

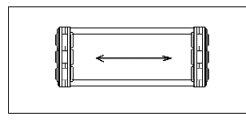

Pitch=P
100 mm

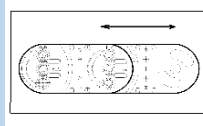

Radius=R
100-500

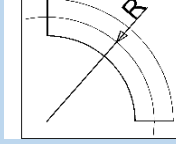

SP

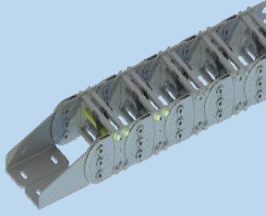
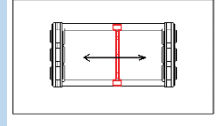

BS/BSS 1000A (STANDARD)
HER BAKLADA ÇİFT ALÜMİNYUM ÇITA TAKILI
İÇ VE DIŞ ÇTALAR SÖKÜLEBİLİR
AYARLANABİLİR PLASTİK SEPERATÖR
KABLO TEMASLARI ÖNLENİR

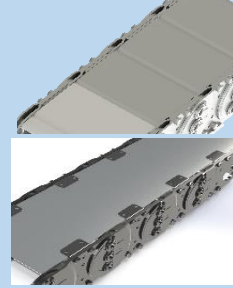

BS/BSS 1000 K
K SERİSİ
ALÜMİNYUM KAPAK SİSTEMİ

K1 SERİSİ
ÇELİK BANT KAPAK SİSTEMİ

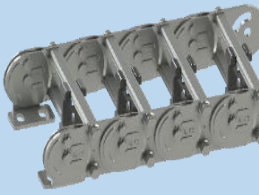

BS/BSS 1000 DF (DOUBLE FRAME)
HER BAKLADA TEK ALÜMİNYUM ÇITA TAKILI
ALT VE ÜST ÇITA SÖKÜLEBİLİR
AYARLANABİLİR PLASTİK SEPERATÖR

BS/BSS 1000 B (LG SERİSİ)

ZİNCİR BOYUNCA OPTİMUM KABLO YÖNLENDİRME
KABLOYU HASAS SARAR VE KESMEZ
ÇİVATA BİRLEŞTİRMELİ SÖKÜLEBİLİR

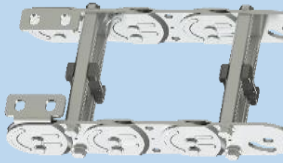
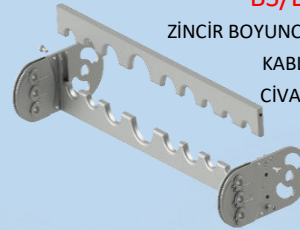

BS/BSS 1000 SF (SINGLE FRAME)
İKİ BAKLADA BİR ALÜMİNYUM ÇITA TAKILI
İÇ VE DIŞ ÇTALAR SÖKÜLEBİLİR
AYARLANABİLİR PLASTİK SEPERATÖR

BS/BSS 1000 PF (PIPE FRAME)

ÇELİK BÖLÜCÜLERLE VE DÖNEBİLEN
BORULARLA YUMUŞAK KABLO DESTEĞİ
YUMUŞAK KILIFLI MEDYA HORTUM VE
KABLOLARINI KULLANMAK İÇİN İDEALDİR

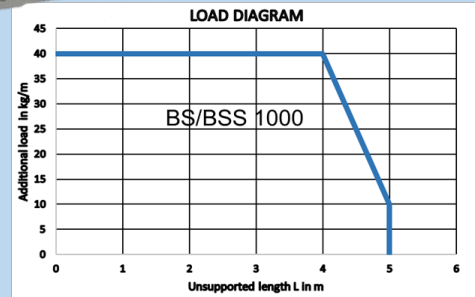
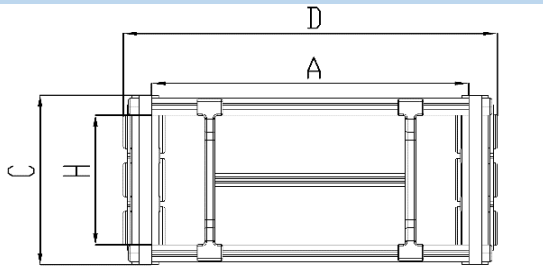

ÜRÜN KODU

H=İÇ YÜKSEKLİK

A=İÇ GENİŞLİK

C=DIŞ YÜKSEKLİK

D= DIŞ GENİŞLİK

R=KIVRILMA YARIÇAP

PRODUCT CODE

INNER HEIGHT

INNER WIDTH

OUTER HEIGHT

OUTER WIDTH

BENDING RADIUS

BS 1000

60 mm

40-500 mm

79

A+19 mm

100-500

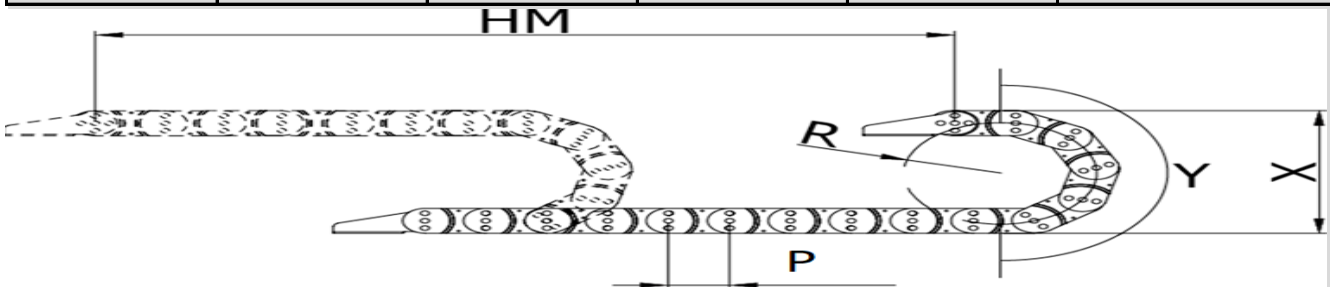

L= KULANILACAK
MİKTAR

HM= HAREKET
MESAFESİ

X= MONTAJ YÜKSEKLİĞİ

P= HATVE

Y= RADIUS MESAFESİ

CHAIN LENGHT

MOVEMENT DISTANCE

MOUNTING HEIGHT

PITCH

RADIUS DISTANCE

$L=HM/2+Y$

$Y=R/\pi$

$X=RX^2+C$

ÖRNEK SİPARİŞ ORDER EXAMPLE
BS1000(BS60) A100 R100 L5000

ÜRÜN KODU	A= ACIK K= KAPALI B =ÖZEL İŞLEME(LG)	R=KIVRILMA YARI ÇAPI	L=ZİNCİR BOYU
PRODUCT CODE	A= OPEN K= CLOSED B =(LG)	R=BENDING RADIUS	(CHAIN LENGTH)
BS1000	A 100	R100	L=5000 mm

ÖRNEK GÖRÜNÜM SAMPLE VIEW

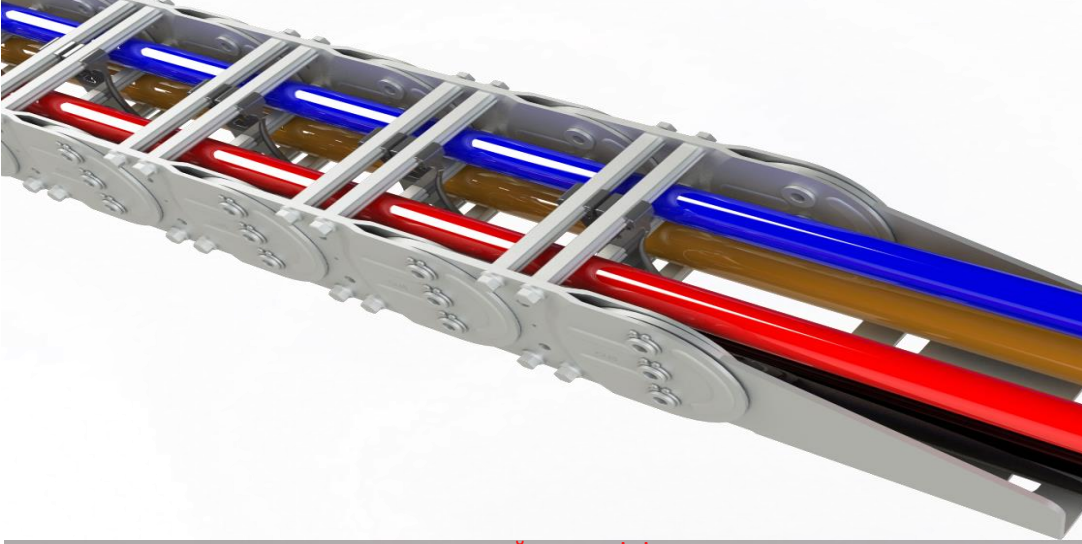

BAĞLANTI TİPİ CONNECTION TYPE

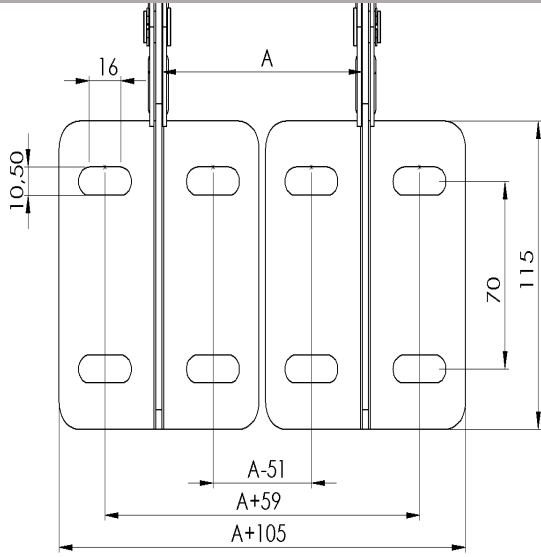

BS/BSS1000 = BS/BSS 60

AYAK BAĞLANTI TİPLERİ RESİMDEKİ GİBİDİR
END BRACKET TYPES AS IN THE PICTURE
AYRICA DİK BAĞLANABİLİR
ALSO VERTICAL CONNECTING IS POSSIBLE



SEPERATİST

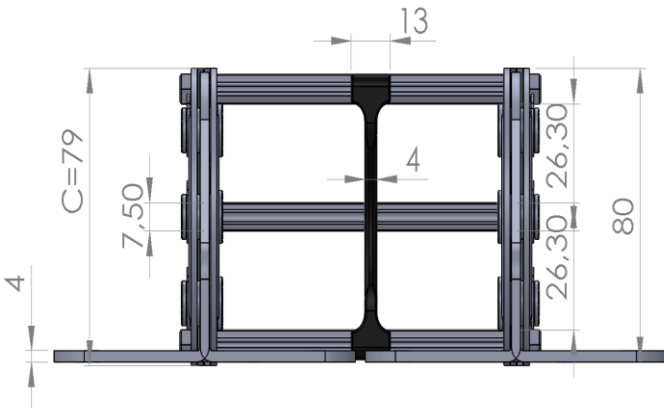

KABLO KANALI PLASTİK SEPERATÖRLERLE BÖLÜNÜR
CABLE CHANNEL DIVIDED WITH PLASTIC SEPERATORS
ÇALIŞIRKEN İÇERDE SÜRTÜNMEYİ ÖNLER
prevents internal friction
YUMUŞAK DOKULU MEDYA KABLOLARI İÇİN İDEALDİR
IDEAL FOR SOFT TISSUE MEDIA CABLES