

BS/BSS 0500 = BS/BSS 22

Inner heights=H
İÇ YÜKSEKLİK
22 mm

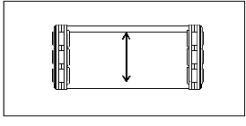

Inner widths=A
İÇ GENİŞLİK
40-300 mm

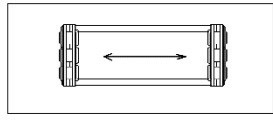

Pitch=P
ADIM
50 mm

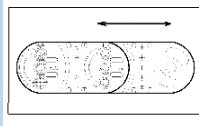

Radius=R
KIVRILMA YARIÇAPI
50-400

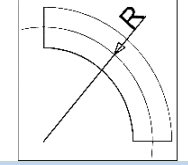

SP

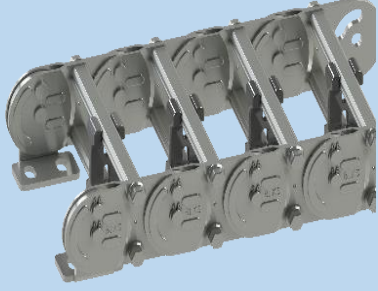
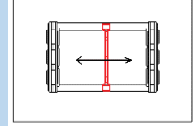

BS/BSS 500 A (STANDARD)

HER BAKLADA ALÜMİNYUM ÇITA TAKILI

SINGLE ALUMINUM FRAME FITTING IN EACH LINK

ALT ÇITA VE ÜST ÇITA İHTİYACA GÖRE SÖKÜLEBİLİR

DETACHABLE FRAMES

AYARLANABİLİR PLASTİK SEPERATÖR BÖLÜCÜLERLE KABLO TEMASLARI ÖNLENİR

ADJUSTABLE PLASTIC SEPERATORS PREVENT INTERNAL FRICTION AND TOUCHING

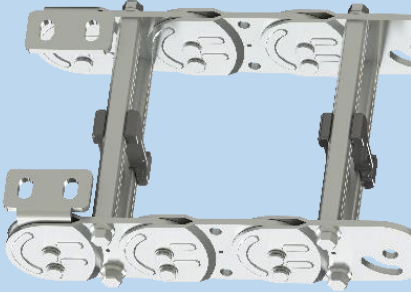

BS/BSS 500 SF (SINGLE FRAME)

İKİ BAKLADA BİR ALÜMİNYUM ÇITA TAKILI

SINGLE ALUMINUM FRAME FITTING IN TWO LINKS

ALT ÇITA VE ÜST ÇITA İHTİYACA GÖRE SÖKÜLEBİLİR

DETACHABLE FRAMES

AYARLANABİLİR PLASTİK SEPERATÖR BÖLÜCÜLERLE KABLO TEMASLARI ÖNLENİR

ADJUSTABLE PLASTIC SEPERATORS PREVENT INTERNAL FRICTION AND TOUCHING

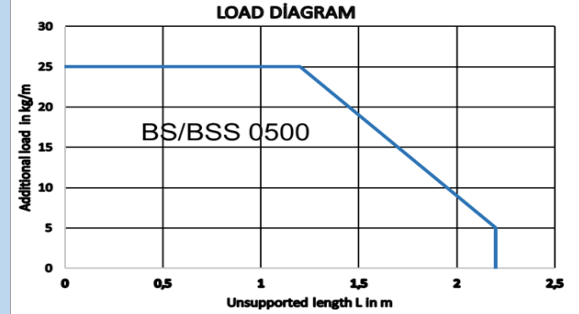
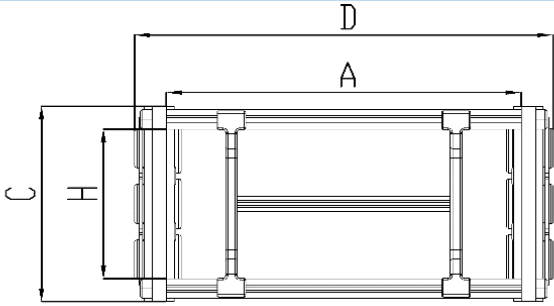

ÜRÜN KODU PRODUCT CODE	H=İÇ YÜKSEKLİK INNER HEIGHT	A=İÇ GENİŞLİK INNER WIDTH	C=DIŞ YÜKSEKLİK OUTER HEIGHT	D= DIŞ GENİŞLİK OUTER WIDTH	R=KIVRILMA YARIÇAPI BENDING RADIUS
BS 0500	22 mm	40.....300 mm	40 mm	A+14 mm	50.....400 mm

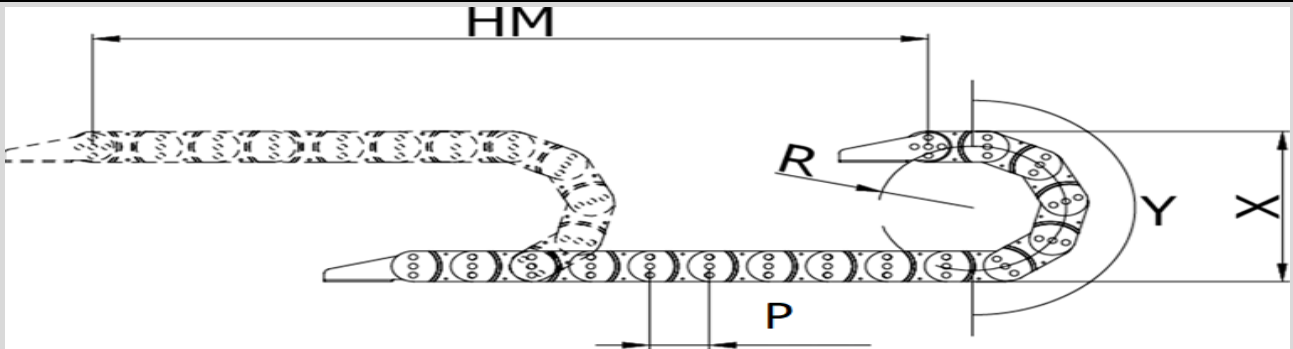

L= KULANILACAK MİKTAR CHAIN LENGTH	HM= HAREKET MESAFESİ MOVEMENT DISTANCE	X= MONTAJ YÜKSEKLİĞİ MOUNTING HEIGHT	P= HATVE PITCH	Y= RADIUS MESAFESİ RADIUS DISTANCE
$L=HM/2+Y$		$Y=R/\pi$	$X=RX2+C$	

ÖRNEK SİPARİŞ ORDER EXAMPLE
BS0500(BS22) A100 R50 L5000

ÜRÜN KODU	A= ACIK K= KAPALI B =ÖZEL İŞLEME(LG)	R=KIVRILMA YARI ÇAPI	L=ZİNCİR BOYU
PRODUCT CODE	A= OPEN K= CLOSED B =(LG)	R=BENDING RADIUS	(CHAIN LENGTH)
BS0500	A 100	R50	L=5000 mm

ÖRNEK GÖRÜNÜM SAMPLE VIEW



BAĞLANTI TİPİ CONNECTION TYPE

BS/BSS0500 = BS/BSS22

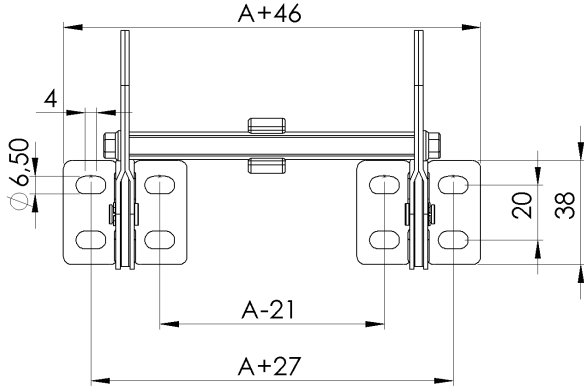

AYAK BAĞLANTI TİPLERİ RESİMDEKİ GİBİDİR
END BRACKET TYPES AS IN THE PICTURE
AYRICA DİK BAĞLANABİLİR
ALSO VERTICAL CONNECTING IS POSSIBLE



SEPERATÖR SEPERATIST

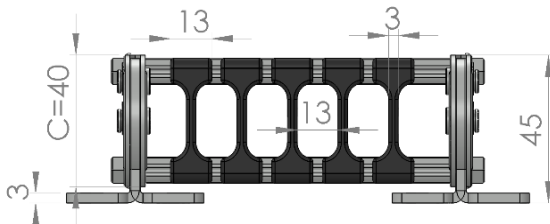

KABLO KANALI PLASTİK SEPERATÖRLERLE BÖLÜNÜR
CABLE CHANNEL DIVIDED WITH PLASTIC SEPERATORS
ÇALIŞIRKEN İÇERDE SÜRTÜNMEYİ ÖNLER
PREVENTS INTERNAL FRICTION
YUMUŞAK DOKULU MEDYA KABLOLARI İÇİN İDEALDIR
IDEAL FOR SOFT TISSUE MEDIA CABLES