

BS/BSS 7000

Inner heights=H
İÇ YÜKSEKLİK

350mm

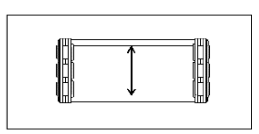

Inner widths=A
İÇ GENİŞLİK

500-1500 mm

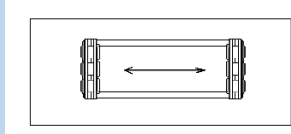

Pitch=P
ADIM

450mm

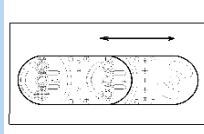

Radius=R
KIVRILMA YARIÇAPI

900-2500

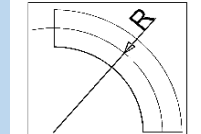

SP

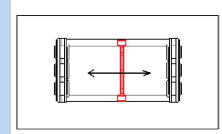

BS/BSS 7000 A

YAN BAKLA EKSTRA BÜKÜMLE GÜÇLENDİRİLMİŞ
HER BAKLADA BÜKÜMLÜ SAC PROFİLTAKILI
İÇ VE DIŞ ÇTALAR SÖKÜLEBİLİR
SABİT ALÜMİNYUM BÖLÜCÜLER
KABLO TEMASLARI ÖNLENİR

bended -reinforced side link
each links are connected with bended steel
inner and outer frames
FIXED ALUMINUM SEPARATORS
cable contact is prevented

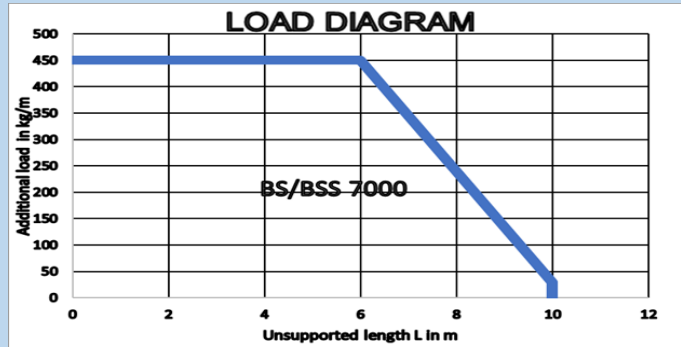
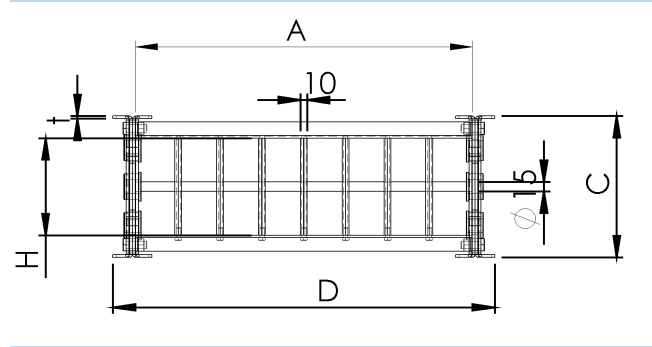
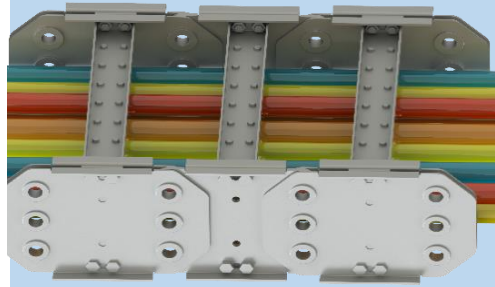

ÜRÜN KODU	H=İÇ YÜKSEKLİK	A=İÇ GENİŞLİK	C=DIŞ YÜKSEKLİK	D= DIŞ GENİŞLİK	R=KIVRILMA YARIÇAPI
PRODUCT CODE	INNER HEIGHT	INNER WIDTH	OUTER HEIGHT	OUTER WIDTH	BENDING RADIUS
BS/BSS 7000	350mm	500-1500 mm	418	A+66 mm	900-2500

ÜRÜN KODU	A=ACIK B=ÖZEL İŞLEME(LG)	R=KIVRILMA YARI ÇAPI
PRODUCT CODE	A= OPEN B=(LG)	R=BENDING RADIUS
BS7000	A 250	R900

L=zincir BOYU (CHAIN LENGTH)
L=5000 mm

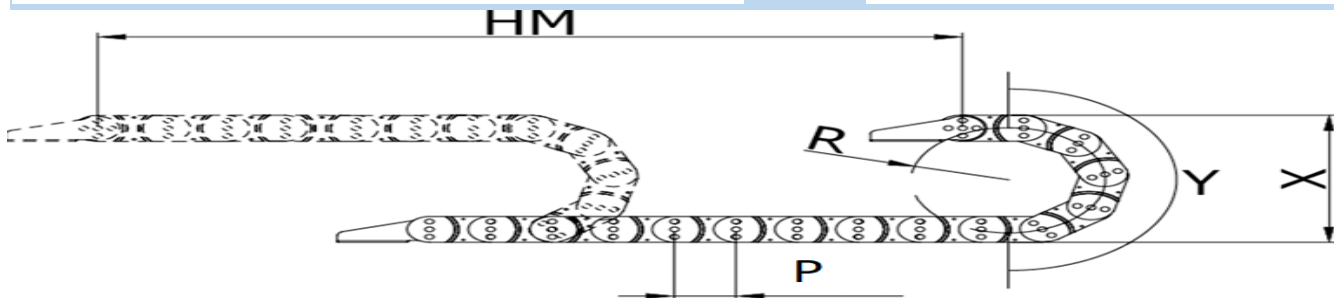
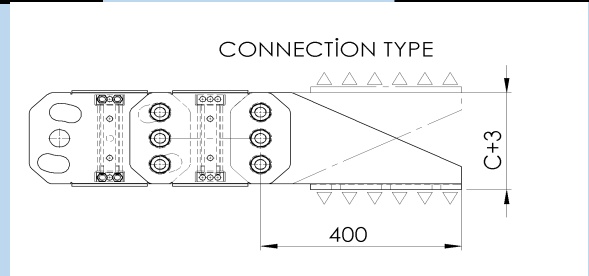
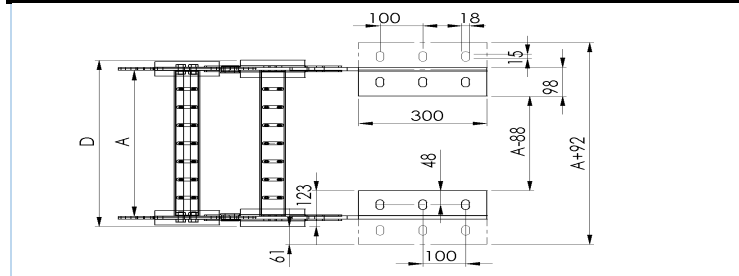

L= KULLANILACAK MİKTAR	HM= HAREKET MESAFESİ	X= MONTAJ YÜKSEKLİĞİ	P= HATVE	Y= RADIUS MESAFESİ
CHAIN LENGHT	MOVEMENT DISTANCE	MOUNTING HEIGHT	PITCH	RADIUS DISTANCE
$L=HM/2+Y$		$Y=R/\pi$		$X=RX2+C$